

1928-31 Ford Cabriolet Upholstery and Top Kits

Classtique Upholstery kits are made from a collection of original patterns taken from cars restored by us since 1960. Our kits have been sold internationally to many professional installers and they have also helped us perfect our patterns to ensure ease of installation. We use high quality materials and high standards to restore your vehicle to near original specifications.

100% satisfaction guarantee if your order is not received as specified. If an error has been made on our part, we will promptly correct it. Please **return the information sheet** at the end of this packet with your order or have all details available when ordering by phone.

Interior Upholstery Kit Specifications

The open car interior kit includes: pre-sewn and padded seat cushion and backrest covers, all panels are covered and ready to install, waterproof automotive panel board on the door panels with pockets and details for year of car, headliner, windlace, installation hardware, and instructions.

1928-29 Coupes: Advise if you want plain or pleated covers

Hardware Parts include: door panel clips, hog rings and pliers, wire brads with needle, screws and washers, and extra cotton padding to re-pad the spring units.

Interior kit Prices

1929 Cabriolet 68A (Grey or Brown Check).....	\$1,175.00
1929 Cabriolet 68A (Bedford Cord).....	\$1,200.00
1930-31 Cabriolet 68B (Grey or Brown Check).....	\$1,175.00
1930-31 Cabriolet 68B (Bedford Cord).....	\$1,395.00
1931 Cabriolet 68C Slant Window (Bedford Cord).....	\$1,450.00
1931 Cabriolet 68C (Brown Leatherette Vinyl).....	\$1,085.00
1931 Cabriolet 68C (Leather & Vinyl Combination).....	\$1,885.00

Rumble Seat Covers and Panels

Rumble panel set includes screws and washers for installation. Rumble cover sets are sewn, padded, and ready to install onto the spring with extra padding and burlap for redoing the springs. Hardware includes: hog rings and pliers, tacks, and welt cord trim to finish the backside of the backrest.

1928-31 Panel Set.....	\$220.00
1928-29 Plain Covers – no channels.....	\$275.00

Classtique Upholstery
 6961 W Shadow Lake Dr
 Lino Lakes, MN 55014

(651) 484-9022
 1-800-208-9032

Web Site: www.ClasstiqueUpholstery.com
 E-Mail: Mike@ClasstiqueUpholstery.com

1930-31 Standard Covers – 4" or 4 ½" channels.....	\$440.00
1930-31 Deluxe Covers – 2 ½" or 3" channels.....	\$475.00
Labor Charge to install Rumble Covers.....	\$375.00

Carpet

Our floor carpet is the wool square weave pattern as original. All sides are bias bound, includes a sewn on pyramid rubber heel pad, correct cutout detailing with a 6 piece fastener set. **1928-29 Advise of brake stick locations**

Our carpets are made with this original cut out design

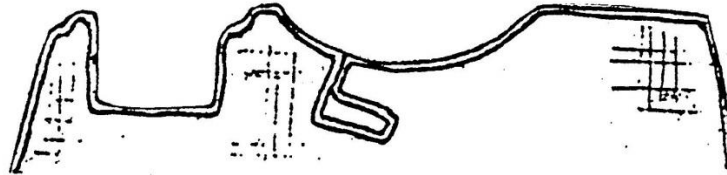

1928-31 Front Carpet.....	\$200.00
1928-31 Rumble Carpet.....	\$150.00
1930-31 Rumble Toe Kick Carpet.....	\$80.00

Outside Top Kits

Top kits include: inside top pad set, roof straps with fasteners, zippered rear curtain, tack rail fasteners, welt trim with welt tips, tacks, and instructions. T-14 is original. Haartz Stayfast cloth is fade and shrink resistant. It is the best top material you can buy.

1929-31 68A, B, C (Short Grain).....	\$850.00
1929-31 68A, B, C (Tan Stayfast).....	\$750.00

Top Boot

1929-31 Top Boot Cover (Short Grain).....	\$325.00	Tan Stayfast Cloth.....	\$350.00
---	----------	-------------------------	----------

NEED TO KNOW ABOUT YOUR 1929-31 Ford Cabriolet (68-A & 68-B)

Please fill out and return with order

Because of the variations please check the following areas against the car. If yours varies from the options provided please let us know. Your order will be custom made based on the measurements you provide.

Top Frame

Style A
(has a solid door header)

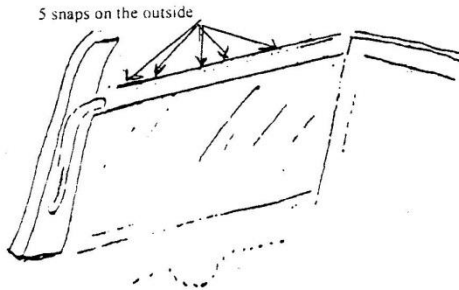

or

Style B
(29,30,&31 had folding door header)

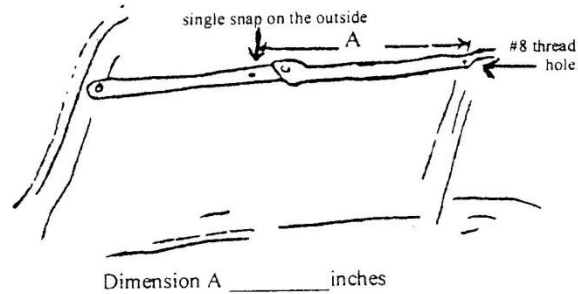

Panels & Pocket

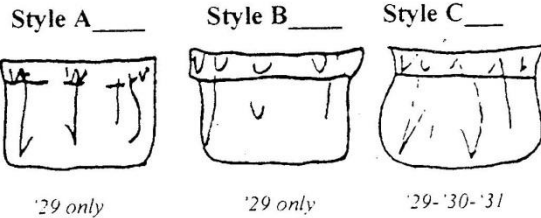
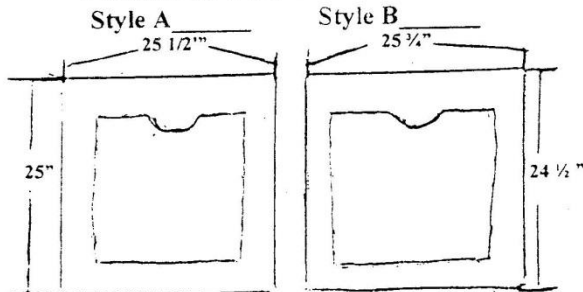

Seat Carriage

('30-'31 68-B)
 Dimension B = 24" - 25" - 26 1/2"

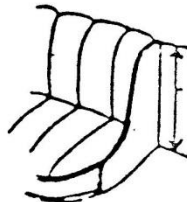

Tray

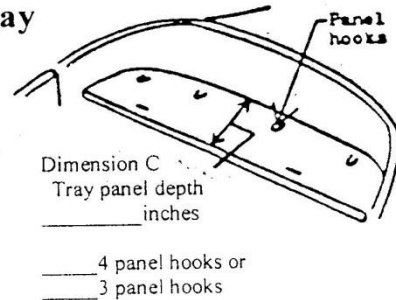

Note: some '30 Cabriolets were made with '29 cushions, without the seat carriage
Please advise if yours is one of these.